

Bioclimatic Pergola

EN13561 Wind Class 6 Rated
Snow Zone 3 Rated

Configuration and size parameters

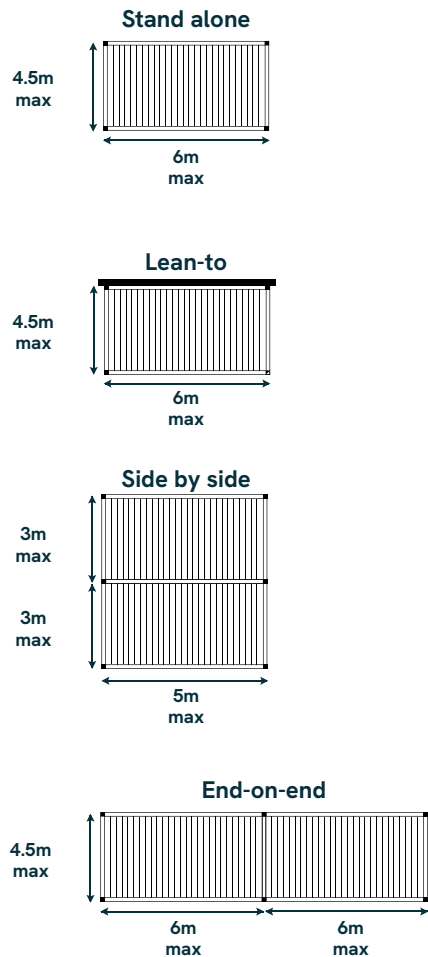

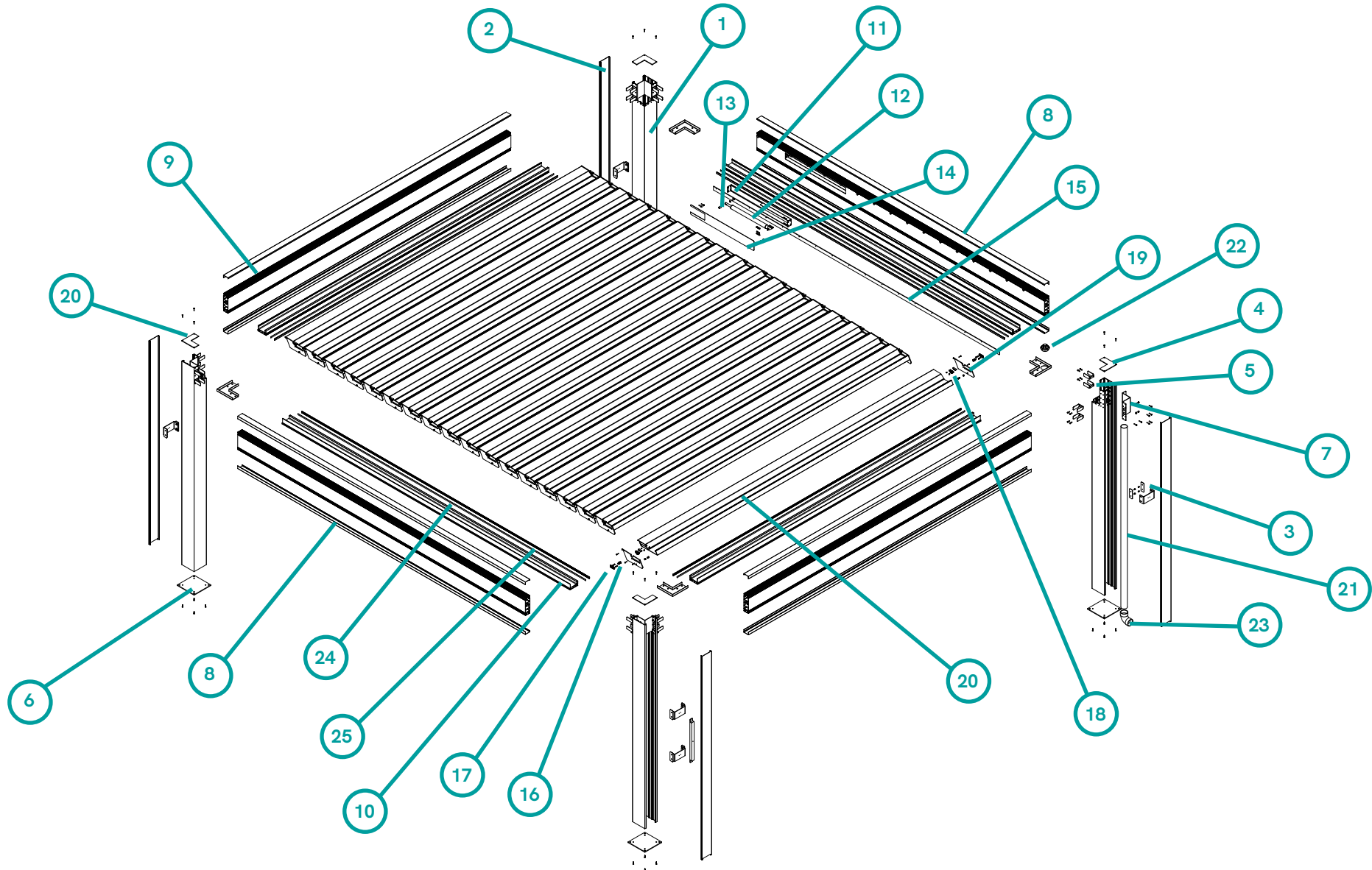

Bioclimatic Pergola

Exploded Drawing



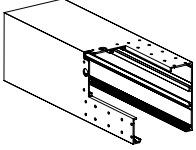
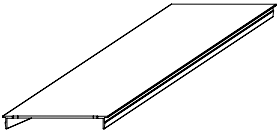
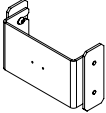
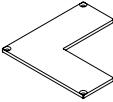
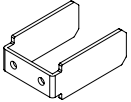
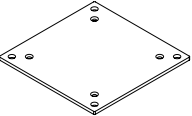
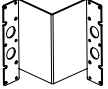
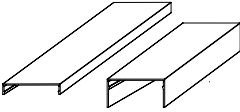

Bioclimatic Pergola

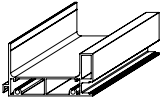
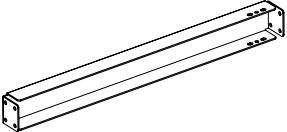
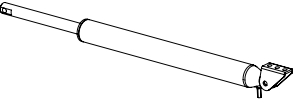
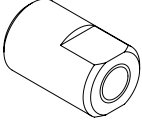
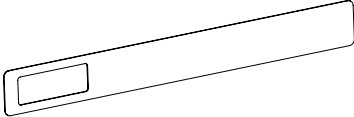
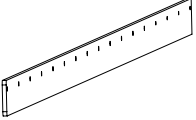
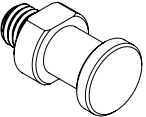
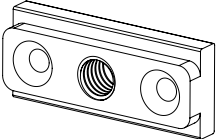
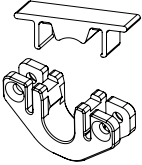
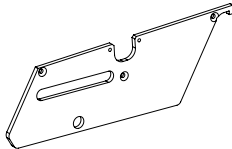
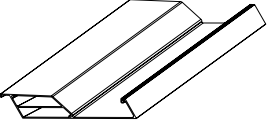
Parts List

				
1. Post	2. Post Cover Plate	3. Post Bracket	4. Post Top Plate	5. Connector Bracket
				
6. Base Plate	7. Internal Corner Plate	8. Edge Cap Profile	9. Perimeter Beam	10. Gutter
				
11. Motor Bracket	12. Motor	13. Motor Louvre Pin	14. Cover Plate	15. Louvre Linking Bar
				
16. Louvre Alex	17. Axle Insert	18. Connector	19. Louvre End Plate	20. Louvre

Bioclimatic Pergola

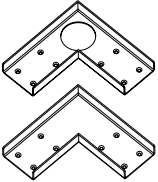
Parts List

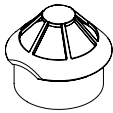
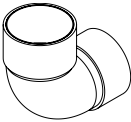
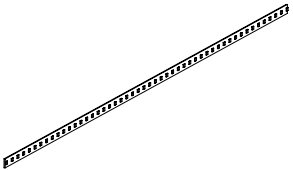
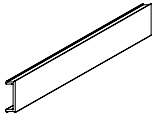
				
21. Gutter Corner Plate	22. Down Pipe	23. Leaf Guard	24. Elbow	25. LED Strip Light
				
26. LED Diffuser				

Electrical Details:

Motor: Teleco Shaku 24V, 2500nm. IP66 rated. Remote controlled via handset.

Lighting: 24V, 8W per m, dimmable. IP65 rated.

Bioclimatic Pergola

Main Profile Dimensions

